

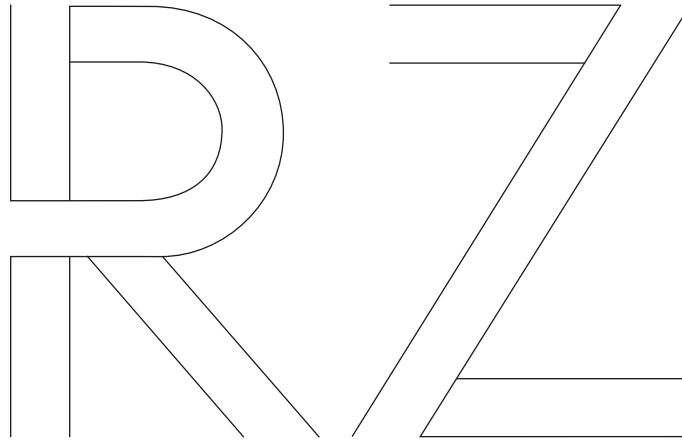

THE ALL-NEW RZ

RZ 450e ALL-ELECTRIC





At Lexus, we have a lot to be proud of. A leader in luxury car electrification for nearly 20 years. Over 2 million Lexus Self-Charging Hybrids on the road across the globe. Cars that stand out for their sophistication, proven quality and award-winning reliability.

These are impressive facts, but for Lexus, performance is more than just numbers. And electrification is more than just batteries and motors.

It's the chance to define a new kind of driving pleasure, where each journey radiates confidence, control and comfort. With your Lexus responding instantly to your every move, you'll enjoy a luxury that is personal, a luxury rooted in the uniquely crafted connection between car and driver.

Just drive the all-new, all-electric RZ 450e luxury SUV and you'll know what we mean..

This is Lexus Electrified.



01. FEEL STRIKING
Pages 04-09

02. FEEL LUXURIOUS
Pages 10-13

03. FEEL EXHILARATED
Pages 14-17

04. FEEL CONNECTED
Pages 18-19

05. FEEL PIONEERING
Page 20

06. FEEL PROGRESSIVE
Page 21

07. MODEL
Pages 22-23

08. GRADES
Pages 24-25

09. FEATURES
Pages 26-29

10. TECHNOLOGY
Pages 30-41

11. ACCESSORIES
Pages 42-43

12. COLOURS
Pages 44-45

13. EQUIPMENT
Pages 46-51

14. TECHNICAL DATA
Pages 52-53

15. FEEL VALUED
Pages 54-55



LEXUS

RZ 450e

RZ 450e
eSUV



FEEL STRIKING

"We are not making a BEV; we are making a Lexus."

TAKASHI WATANABE
LEXUS CHIEF ENGINEER

ELECTRIFYING PERSONALITY

THE ALL-NEW, ALL-ELECTRIC RZ 450e SHOWCASES THE FUTURE
OF 'LEXUS ELECTRIFIED' DESIGN.

With its stunning design, the first fully dedicated Lexus Battery Electric Vehicle (BEV) instantly stands out as the most contemporary of luxury SUVs. The RZ's new spindle body styling is sleek and elegant, with a striking bi-tone bodywork option and sculpted lines that hint at its sporty temperament. From first glance, its wide stance lends it a commanding presence.

A LEXUS FROM EVERY ANGLE

The sleek LED headlights integrated with the spindle body create an immediate impression of harmony and unity. Ultra-slim, they give extra emphasis to the Lexus L-motif of the daytime running lights. Without an internal combustion engine, the bonnet could be lowered, contributing to an aerodynamic silhouette that whets the appetite for the drive experience that lies in store.

Side on, the long wheelbase adds to the impact of the design, expressing the low centre of gravity and optimum weight balance. The imposing bodywork is accentuated by 20" wheels pushed right out to the corners of the car. Highlighted by the wheel arch mouldings, this is clearly an SUV of substance, providing excellent interior space with class leading legroom for all occupants, yet offset by a flowing grace which speaks to its Lexus heritage.

POWERFUL REAR STANCE

Reflecting the car's self-assured posture, the condensed rear end affirms the RZ's qualities of comfortable space and strong driving capabilities, the elongated light bar a powerful reminder of its Lexus bloodline.







FEEL LUXURIOUS

"Our goal was to create the most comfortable car in the world."

TAKASHI WATANABE
LEXUS CHIEF ENGINEER

ART AND CRAFT

BEHIND THE CONTEMPORARY INTERIOR LIES THE CRAFT OF OUR TAKUMI ARTISANS.

To step inside the RZ 450e luxury SUV is to steal a glimpse of the future. It starts with the unique new 'In-ei' illumination that lets you enjoy the shimmering effects of changing light. It carries through to the stunningly modern Tazuna cockpit design, aesthetic yet purposeful, with the layout of instruments positioned in the driver's line of vision. RZ offers a progressive luxury interior exclusively with sustainable, synthetic trims for all variations, complementing the clean electric powertrain. You relax into luxurious 'ultra-suede' seating in a cabin featuring vegan materials.

LUXURY WITH A HUMAN TOUCH

Yet among the modernity it's reassuring to sense the human hand. The world-class quality which pervades every inch of the cabin can be attributed to our famed 'Takumi' craftspeople, their artistry honed over at least 15 years. You feel it in the hand-stitched steering wheel created using thousand-year-old Japanese skills.

ANTICIPATING YOUR EVERY NEED

Comfort in the RZ is more than sumptuous upholstery, exquisite finishing and a roominess which rivals that of larger flagship SUVs. It is Omotenashi, an ancient form of Japanese hospitality centred around anticipating a guest's needs. You can see it in novel features like the smart glass panoramic roof, which is electronically dimmable and does away with the sunshade in favour of more headroom. You see it too in the radiant 'heaters,' which keep the cabin comfortable while saving battery power.

That comfort stays with you throughout your journey, a reminder of the work of the Lexus craftspeople at our Motomachi plant, toiling over every millimetre of your RZ to make this the most serene of experiences.

Discover more about dimmable roof on : <https://www.lexus.eu/car-models/rz-world-premiere/#a-new-way>









THE DRIVE IS EVERYTHING

THE RZ 450e INJECTS EXHILARATION INTO ELECTRIFIED SUV LUXURY.

Its bold demeanour tells you the RZ 450e is built to drive like a true luxury SUV. Its smooth, intuitive driving characteristics make for a performance on the road which exudes confidence, control and comfort in all driving situations. Maximising key BEV qualities, such as fast response and high precision, but with a natural engagement that reflects the definition of luxury at Lexus.

ELECTRIC PERFORMANCE LIKE NO OTHER

Behind the wheel of the all-new RZ, the feeling is a personal one, as if fine-tuned for you alone. Alongside the optimised BEV packaging, exceptional and body rigidity, the lower centre of gravity and breakthrough DIRECT4 all-wheel-drive help give the car exhilarating acceleration, sharp handling and ultra-responsive braking.

The drive is remarkably smooth and effortless, masking the painstaking efforts of Lexus designers, engineers and 'Takumi' master drivers in crafting what we call the electrified 'Lexus Driving Signature'. You're experiencing something unique. Even on normal roads, driving acquires a new exhilaration, a hankering for the next bend or straight.

THE THRILL OF THE DRIVE

Complementing its silky road manners is a real appetite for breath-taking corners. Here the RZ's character again shines: DIRECT4 utilises high-output 150 kW front and 80 kW rear e-Axle electric motors, constantly shifting from front-wheel drive to rear-wheel drive and everything in between. Captivated by the thrill of the drive, it's easy to forget the practicality of this car. Alongside a range of around 400 km^{*1}, you can fast-charge from 0 to 80% in little more than 30 minutes, whilst benefitting from excellent battery efficiency and savings.

But behind the wheel, the RZ is about more than numbers. This is Lexus Electrified at its most exciting.

* WLTP combined cycle

¹ The electric range and electric energy consumption values are measured in a controlled environment on a representative production model, in accordance with the requirements of the new WLTP European Regulation EC 2017/1151 and its applicable amendments. For each individual vehicle configuration, the electric range and electric energy consumption values may be calculated based on the ordered optional equipment. The electric range and electric energy consumption values of your vehicle may vary from those measured or calculated values, as driving behaviour as well as other factors (such as road conditions, traffic, vehicle condition, tyre pressure, load, number of passengers, etc) have an influence on a car's electric range and electric energy consumption. 395 km is the range for a RZ with 20" wheels. For more information regarding the new WLTP test method, please visit: www.lexus.eu/wltp#nedc







DIGITAL TRANSFORMATION

THE RZ 450e IS RICH IN FEATURES TO MAKE LIFE SAFER
AND MORE CONVENIENT.

The new RZ 450e sports all the safety and connectivity technology you would expect from Lexus. And more too. Witness the next-generation Lexus Safety System+ that features levels of intelligent protection never seen before. Proactive Drive Assist, for example, is a Lexus-first which uses Obstacle Anticipation Assist, Deceleration Assist and Steering Assist to make your driving even safer. Meanwhile, if the new Driver Monitor detects you are drowsy or distracted at the wheel, it will emit an alert, or even decelerate and stop the RZ if required. This is in addition to an advanced Pre-Collision System which can detect motorcycles in daytime and bicycles/pedestrians at night. You'll also appreciate the convenience and safety of Digital Panoramic View Monitor, providing a 360° view around and below the car to help you manoeuvre in tight spaces.

INTELLIGENT SAFETY TECHNOLOGY

The exclusive new Safe Exit Assist function prevents the driver and passengers from opening the door in the event of traffic such as cars or cyclists approaching from the rear. Lexus estimates this system can help prevent more than 95% of the accidents caused by door opening.

THE LATEST MULTIMEDIA SYSTEMS

Inside the cabin, the extra-large 14" touchscreen is the digital hub for an array of exciting multimedia and connectivity features. Its high-definition screen is perfect for displaying your smartphone apps. The fast and intuitive Lexus Link Multimedia on the RZ is all the more convenient when used with the intelligent Lexus Voice Assistant, which responds to natural voice commands.

ENHANCING YOUR LIFE WITH LEXUS LINK

The Lexus Link app enriches your life with the all-electric RZ. As well as monitoring the battery charge level on your smartphone, you can instantly locate available charging stations across Europe. With Lexus Link connected services, you can even switch on climate control functions remotely, ensuring the cabin is at just the right temperature when your journey begins. At the press of a button, Advanced Park scans the surroundings before parking your RZ and even allows you to save spaces that you use frequently. And when you get to your destination, Remote Park helps you park the RZ.





FEEL PIONEERING

POWERING THE DREAM

In the 1990s, thirsty petrol or diesel engines were the unchallenged norm for luxury cars. As the millennium turned, the world was waking up to global warming and the need to reduce emissions through electrification. A new drivetrain solution was required. And the first luxury carmaker to step up to the mark was Lexus.

With all key hybrid components developed and manufactured in-house, our electrified hybrids have proved themselves to be uniquely refined, exhilarating to drive and exceptionally strong.

Two decades on, our dream at Lexus of low-emission luxury travel has long become a roadmap. And with each electrified car we launch, the final destination edges ever closer.



FEEL PROGRESSIVE

A PIONEER AND LEADER IN LUXURY CAR ELECTRIFICATION

Since the launch of our first luxury sedan over 30 years ago, Lexus has become a synonym for exceptional design, quality and refinement. Perhaps most importantly, we're also a pioneer and leader in luxury car electrification. A company that never stops innovating and working to anticipate drivers' needs. It's this unique approach that resulted in the world's first luxury hybrid in 2005 - the RX 400h SUV.

SELF-CHARGING HYBRID, PLUG-IN HYBRID OR ALL-ELECTRIC

Today, Lexus offers Self-Charging Hybrid, Plug-in Hybrid and All-Electric models, with the majority of premium hybrids on the road sporting the Lexus badge. No other luxury carmaker can rival our experience in developing, building, servicing and recycling hybrids. Our Self-Charging Hybrids do not require plugging in and are capable of driving in Electric vehicle (EV) mode using no petrol.

Spearheading our new 'Lexus Electrified' vision, we introduced the first all-electric Lexus, the UX 300e. Marking the next chapter of electrification, the first Lexus Plug-in Hybrid, the NX 450h+, has extended our electrified line-up even further, along with the RZ 450e, built on a dedicated electric vehicle platform.

THE FUTURE IS 'LEXUS ELECTRIFIED'

Despite the tremendous success of the Lexus Self-Charging Hybrid range, resting on our laurels is not an option. Which is why we launched the 'Lexus Electrified' vision and the LF-30 'electrified' concept. Created to transform driving enjoyment to the next level, 'Lexus Electrified' is an integrated approach to electric powertrains, advanced posture control and other electrification technologies. Demonstrating our vision, the LF-30 'electrified' concept's bold exterior and driver-centric cockpit embody everything that 'Lexus Electrified' stands for. Benefitting from over two decades of electrification experience, with its four in-wheel electric motors, steer-by-wire and Lexus Advanced Posture Control, it delivers a driving experience like no other.

Discover more: www.lexus.eu/electrified

01. MEET THE ALL-ELECTRIC RZ 450e

The RZ 450e is the first Lexus Battery Electric Vehicle (BEV) to be developed from the ground up. Not a car that simply adopts battery electric power in place of a conventional engine; it goes much further to realise the exciting potential of new technologies that enhance performance and driving pleasure. The front and rear e-Axles that work in conjunction with the new DIRECT4 all-wheel drive torque control are but one example. The fundamentals of handling and responsiveness are secured with a dedicated new electric vehicle platform, which brings excellent body rigidity, a low centre of gravity and a long wheelbase. With its all-electric performance, the RZ will help us progress towards carbon neutrality and a sustainable society.

02. E-AXLES CONTROLLED BY DIRECT4

The RZ features the new DIRECT4 system, an exclusive and intelligent technology which constantly balances the traction between front and rear e-Axles, delivering quiet, efficient and seamless driving force. The front e-Axle produces 150 kW and the rear 80 kW, giving a total power output of 230 kW. The result is stress-free performance, with intuitive operation strengthening the connection between car and driver.

03. PIONEERING BATTERY TECHNOLOGY

The RZ 450e uses a lithium-ion battery in a stack comprising 96 cells, with a total output of 71.4 kWh. The battery is located beneath the cabin and forms an integral part of the platform. Its position also contributes to the car's low centre of gravity. Battery durability was a key consideration for Lexus engineers, in particular the level of long-term performance. The RZ's battery is expected to retain more than 90% of its capacity for up to 10 years, thanks to a series of measures to safeguard quality and performance. A range of around 400 km¹ in the combined WLTP cycle is anticipated for the new RZ 450e.

04. RAPID BATTERY CHARGING

The battery can be fast-charged without compromising safety or service life, 150 kW power providing a charge up to 80% in around 30 minutes². The RZ 450e's exceptional efficiency is not only due to the outstanding battery quality; world-class aerodynamics and electric motors play their part.

05. HIGH BATTERY DURABILITY

Battery durability is industry-leading and supported by our 1 million km extended battery care programme. The RZ 450e also has an efficient and effective heating system that optimises battery performance and range, even in sub-zero temperatures.

¹ The electric range and electric energy consumption values are measured in a controlled environment on a representative production model, in accordance with the requirements of the new WLTP European Regulation EC 2017/1151 and its applicable amendments. For each individual vehicle configuration, the electric range and electric energy consumption values may be calculated based on the ordered optional equipment. The electric range and electric energy consumption values of your vehicle may vary from those measured or calculated values, as driving behaviour as well as other factors (such as road conditions, traffic, vehicle condition, tyre pressure, load, number of passengers, etc) have an influence on a car's electric range and electric energy consumption. 395 km is the range for a RZ with 20" wheels. For more information regarding the new WLTP test method, please visit: www.lexus.eu/wltp#nedc

² Approximate charging time based on internal measurements and predicted values, intended solely for comparison between different models. The time required until completion of charging may vary due to factors such as the age, type, condition and temperature of the charging unit, the age, type, condition, charge level and temperature of the drive battery, the outside air temperature, and the specifications of the power supply.

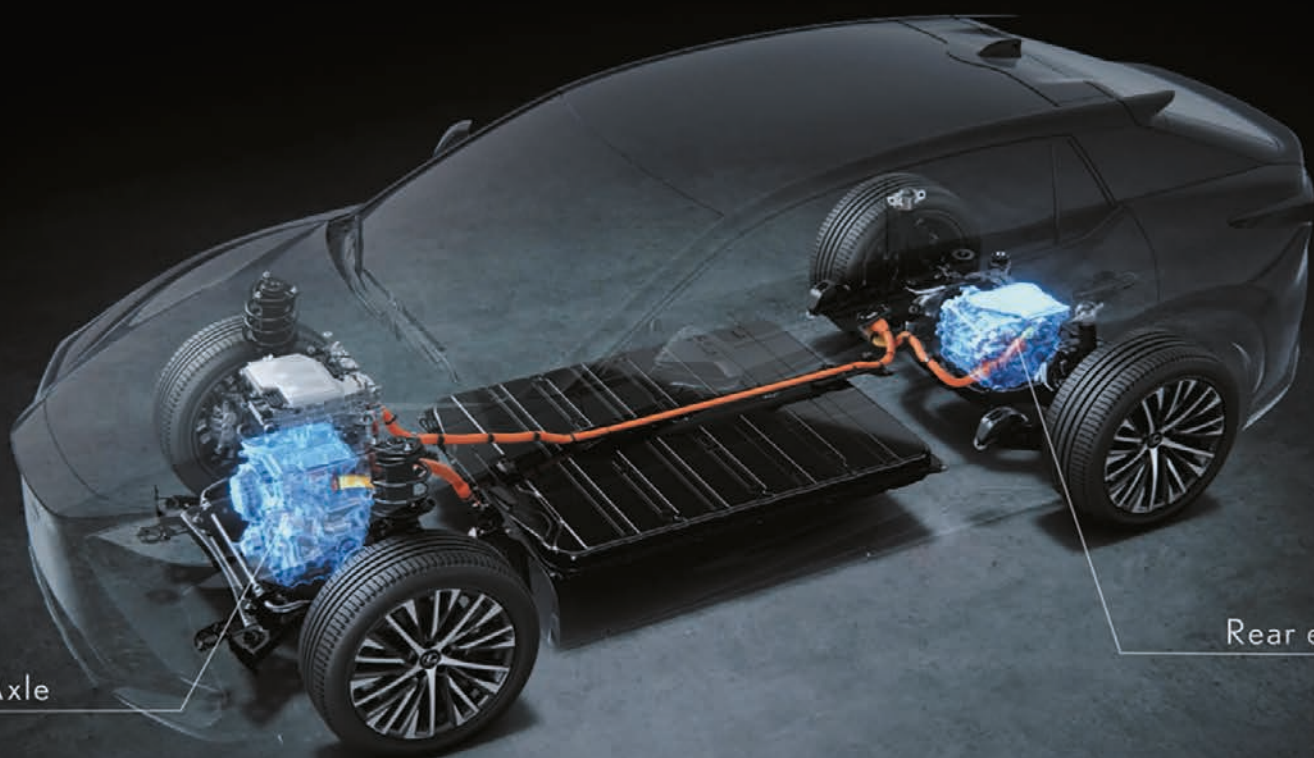

Front eAxle

Rear eAxle



COMFORT

- 18" alloy wheels, machined finish, 235/60 (fr) and 255/55 (rr) R18 tyres
- Resin moulding around wheel arches
- Standard roof
- Rear-view mirror, electro chromatic (auto-dimming)
- Fabric upholstery
- Parking assist monitor with on-screen guides
- Lexus Link Pro - 14" touchscreen display
- Lexus Link Pro Embedded Hybrid Navigation**
- 10-speaker premium audio system



GRADES

EXECUTIVE

- 20" alloy wheels, machined finish, 235/50 (fr) and 255/45 (rr) R20 tyres
- Resin moulding around wheel arches
- Standard roof
- Digital rear-view mirror*
- Tahara trim
- Digital Panoramic View Monitor (PVM)*
- Lexus Link Pro - 14" touchscreen display
- Lexus Link Pro Embedded Hybrid Navigation**
- 10-speaker premium audio system



LUXURY

- 20" alloy wheels, dark premium metallic, 235/50 (fr) and 255/45 (rr) R20 tyres*
- Astral Black moulding on wheel arches
- Panoramic glass sunroof, dimmable*
- Rear-view mirror, electro chromatic (auto-dimming)
- Ultrasuede® upholstery
- Digital Panoramic View Monitor (PVM)
- Lexus Link Pro - 14" touchscreen display
- Lexus Link Pro Embedded Hybrid Navigation**
- 13-speaker Mark Levinson® Premium Surround Sound System*



* Options may be shown and availabilities may differ in certain markets.

** Premium Connectivity pack is included with Lexus Link Pro for the first 4 years of ownership, and renewable thereafter on a subscription basis.

01. 'SEAMLESS E-MOTION' DESIGN

Inspired by the "Seamless E-motion" design concept, the front clearly positions the RZ 450e as an all-electric vehicle. With no conventional engine, the bonnet has been lowered and the air intakes reduced. The bold Lexus signature spindle shape is applied three-dimensionally to the front of the vehicle, resulting in a new, simple form, which captures technological evolution, function and performance.

02. COLOUR DESIGN

The RZ's look is accentuated by finishing what would usually be the grille area in the car's body colour and blacking out the area to each side. Enhanced design flexibility has also allowed more muscular front wings to be produced. The effect is heightened by an optional new bi-tone bodywork which extends the contrasting black area from the roof to the bonnet.

03. POWERFUL SILHOUETTE, WIDE STANCE

The car's flowing side profile peaks towards the rear, creating a powerful silhouette, while the sharp frontal design generates a sense of power and movement. From behind, the rear section affirms the car's SUV qualities of comfortable space and strong driving capability. The long, 2,850 mm wheelbase adds to the impact, expressing the low centre of gravity and excellent balance. The wheels - standard 18" or 20" for higher grades - are placed at the corners of the car.

04. QUADRUPLE LED HEADLIGHTS

The headlights are unified with the spindle body. Sleek and ultra-slim, they add extra emphasis to the Lexus L-motif of the daytime running lights, while the principal headlight lamps and turn indicators are less prominent.

05. HIGH-TECH REAR LIGHT, NEW LEXUS REAR BADGE

The RZ 450e's futuristic character is underlined by its sophisticated high-tech rear look. The split roof spoiler extends the design rearwards and contributes to the car's stable performance. The elongated LED light bar across the width of the car is a hallmark of Lexus Electrified design. Here it has a sharp, minimalist look to give the impression of simplicity and precision, reinforced by the distinctive new Lexus badge.

06. HEAT-SHIELDING, DIMMABLE PANORAMIC ROOF

Available as an option, the futuristic panoramic roof increases the feeling of space and light in the cabin. Its glass has a coating that reflects infra-red radiation and reduces heat on sunny days, while helping keep warmth inside the cabin in cold weather. Doing away with the roller shade saves weight which improves handling, and also allows for the widest panoramic roof in any Lexus.

07. E-LATCH

The RZ 450e is equipped with our new e-Latch technology, a smooth, one-touch electronic door release system. Its operation is linked to the car's Blind Spot Monitor to provide Safe Exit Assist, which cancels the door opening if vehicles or cyclists are detected approaching from the rear. This innovation is expected to help prevent 95% of door opening accidents.



01-02-03



04



05



06



07

01. TAZUNA COCKPIT

The RZ 450e's cockpit represents a bold evolution of our Tazuna concept, bringing together the driver's position at the wheel and the precise arrangement of the meters, controls and touchscreen display to create a space where only small hand and eye movements are required to control the vehicle. The principle is inspired by the small adjustments of the reins ("Tazuna") which a rider uses to control a horse.

02. ERGONOMIC DESIGN

The arrangement of the Head-Up Display and 14" multimedia display have also been optimised and the instrument panel set low, further improving the driver's line of sight. Our designers also created a clean and minimalistic look with fewer elements and less ornamentation, while still using high quality materials. The centre console features a new dial-type control for the shift-by-wire system, reflecting the overall design simplicity.

03. "OMOTENASHI" WELCOME

Our signature Omotenashi Japanese hospitality is demonstrated by the welcome sequence that starts when you approach the RZ 450e. The door handle puddle lights and daytime running lights illuminate and as the door is opened, the instrument panel lights up. On closing the door, the RZ's silhouette appears in the multi-information display and when the brake pedal is depressed, the power button pulsates. Switching on the car initiates a start-up animation with graphics and sound.

04. AMBIENT MOOD SELECTOR

The cabin is designed as a light and open space, enhanced by ambient lighting with a wide spectrum of colour variations to suit the mood of the journey. Another expression of the Lexus 'Omotenashi' hospitality, the Lexus Mood Selector allows occupants to tailor the RZ's ambient lighting from a palette of 64 colours and bespoke illumination effects known as 'In-ei'.

05. SEAT DESIGN

Creating a spacious cabin, the wide-open feel under the panoramic roof complements the ample legroom and headroom. Comfort is addressed by details such as the design of the front seats, with particular attention paid to the cross-sectional shape and the bolsters. The seat construction sets the upholstery seams deeper in the structure, helping the occupant maintain a better posture and with less upward pressure when cornering. 8-way power adjustment, plus lumbar support, is available for the front seats on high grade models. The performance of the integrated seat heating and ventilation has also been optimised.

06. VEGAN LEATHER / "ULTRASUEDE®" SEATS

RZ seats can be upholstered with ultrasuede and animal-free leather to support the low-emission lifestyles and voices of customers who are highly conscious of ethical living and sustainable environments.

07. RADIANT HEATER TO DIRECTLY HEAT OCCUPANTS

Seamlessly integrated into the S-Flow climate control system, new radiant heaters are positioned in front of the driver and front passenger, beneath the steering column and lower instrument panel. Provided in addition to seat heaters and a heated steering wheel, they help speed up warming for the driver and front passenger. As with the panoramic roof that creates shade to cool the cabin, the heaters help save energy by directing heat just where it is needed, thus reducing the load on the climate control system.

08. ADVANCED NOISE REDUCTION

To achieve class-leading cabin quietness, acoustic-quality glass is used for the windscreen. Flush door mouldings and a twin-latch system for the bonnet further contribute to reducing intrusive noise in the cabin, while the wheel arch liners minimise the sound of water splash. Among the many other noise-reducing features on the RZ 450e are: a continuous rubber seal under the bonnet, which limits air flowing out from the e-compartment; the turbulence-reducing A-pillar design; and foam coating at the base of the front and centre pillars.



01. EXTRA LARGE 14" TOUCHSCREEN

Perfectly positioned for relaxing interaction while you drive, this 14" High Definition touchscreen is one of the largest available today and allows you to smoothly access information like navigation, audio and climate control.

02. LEXUS LINK MULTIMEDIA

Lexus Link Multimedia is fast and intuitive to use, with excellent resolution on the large 14" touchscreen. With Lexus Link Pro using embedded navigation, it is the first system of its kind with cloud navigation to regularly update maps and traffic data. Connected services and other software are 'kept up to date' thanks to "Over The Air" (OTA) technology, meaning you'll always have the latest connected experience.

03. LEXUS VOICE ASSISTANT

Artificial Intelligence and the cloud work together in the sophisticated Lexus Voice Assistant, which spares grappling with buttons while you're concentrating on the road ahead. This newly developed "Hey Lexus" voice assistant understands natural language and the context of statements such as "I'm hungry" or "I'm cold" and can even recognise which front passenger is speaking.

04. LEXUS LINK CONNECTED SERVICES

Welcome to the Lexus Link app, a new world of connectivity created to complement our unique 'Omotenashi' service experience. Its smart and bespoke features help you plan a journey, find a parking space, schedule a service or even improve your driving style. Transform your time with the new RZ 450e, using services like:

- Driving Analytics: Tracks your journeys, driving style and lets you record business trips
- Find my Car: Locates and guides you back to your Lexus
- eCare: Lets you manage the service and maintenance of your RZ
- Warning Lights: Explains the meaning of each warning light and any action you should take
- Car status: Notifies you if you've left the car windows open or forgotten to switch off the headlights. You can also check if your car is locked

05. LEXUS LINK CONNECTIVITY FOR YOUR BEV

For a seamless electrified experience, you can monitor the charge level and range of your RZ 450e remotely, on your mobile. When you subscribe to the Lexus Charging solution, Lexus Link also locates charging stations across Europe, allowing you to check availability, charging speed and price, and offers services like:

- Remote control and scheduling of charging
- Access to an extensive European network of public charging facilities

06. LEXUS LINK PREMIUM CONNECTIVITY

As an RZ 450e owner, you'll enjoy all the benefits of Lexus Link Standard Connectivity free of charge over the entire lifetime of your car. The Lexus Link Premium Connectivity pack is also free for the first 4 years of ownership, and thereafter on a subscription basis. It includes pioneering features such as:

- Cloud-based navigation & Voice Assistant
- Road Events & Real Time Traffic information
- On- and off-street parking availability
- Remote Climate: All RZ grades offer remote control of steering wheel heating, seat heating and adjustment of the cabin temperature



01. SOUND ENGINEERING / ACTIVE SOUND CONTROL

While the RZ 450e's electric drivetrain produces less noise, its quiet performance often makes sounds from outside surroundings more noticeable. Thus the RZ's engineers and designers made it a priority to ensure the cabin environment was appropriately quiet. This included applying an advanced version of Active Sound Control, which now uses the car's audio speakers to produce sounds that stimulate an emotional connection between car and driver.

02. 10-SPEAKER PREMIUM AUDIO

A 10-speaker premium audio system is fitted as standard on all grades. This features an FM RDS tuner, Digital Audio Broadcasting and Bluetooth connectivity and offers greater fidelity with large speakers in the front doors.

03. 13-SPEAKER MARK LEVINSON® SOUND

The RZ 450e's new 13-speaker Mark Levinson® Premium Surround system is tailored to the acoustic properties of the cabin. Featuring a 224 mm subwoofer and 1,800 Watts of amplified power, it delivers a 12-channel amplifier sound to create a digital home-theatre experience with Clari-Fi™ that rebuilds sound lost in MP3 digital compression.

04. SMARTPHONE CONNECTIVITY / WIRELESS CHARGING / USB PORTS

With Android Auto® or wireless Apple CarPlay®, the new RZ 450e allows you to easily display and access many of your smartphone's apps on the 14" touchscreen. A wireless charging tray is available, with 50% quicker charging performance. Convenience for everyone on board is addressed by five USB ports in the cabin, three on the front and two on the rear of the centre console.

05. MULTI-INFORMATION DISPLAY

Integrated into the main driving instruments, the 7" colour TFT (Thin Film Transistor) display keeps you informed about all key data including safety warnings and navigation directions. For a more dynamic and engaging experience, the display will adjust its look and content depending on which mode you are in.

06. EXTRA-WIDE 10" HEAD-UP DISPLAY

Vehicle data is projected in colour directly onto the windscreen via a large 10" Head-Up Display, which lets you check navigation, safety features, car information and audio settings without taking your eyes off the road ahead. Its operation is seamless, thanks to touch switches on the steering wheel.



01. 3RD GENERATION LEXUS SAFETY SYSTEM +

The RZ 450e benefits from the advanced active safety and driver assistance systems featured in the latest 3rd generation of Lexus Safety System + with upgraded and additional functions offering increased accident risk detection. Further advances introduced with the new RZ 450e include Proactive Driving Assist with steering assist and a new Driver Monitor to check drivers for signs of fatigue or distraction. Additionally, Proactive Driving Assist uses the front camera to determine the angle of a bend, adjusting the steering appropriately when approaching and making a turn.

02. ENHANCED PRE-COLLISION SYSTEM

Alongside detecting motorcycles during daytime, the Lexus Pre-Collision System allows more potential collisions to be avoided, such as at right / left turns, and with cut-in traffic. It can also recognise collision risks with oncoming traffic or crossing pedestrians when making a turn at a junction. The ability to avoid an impact is increased by Emergency Steering Assist.

03. DYNAMIC RADAR CRUISE CONTROL

This system uses the millimetre-wave radar sensor and a camera to detect the vehicle in front and maintain an appropriate distance. If the vehicle in front comes to a halt, the RZ 450e will stop too. When the vehicle moves off again, you will too. It quickly recognises traffic cutting in front and, in conjunction with Lane Trace Assist, follows a more natural line through bends. Dynamic Radar Cruise Control will also prevent you from driving inside a slower vehicle driving in the outside lane. And when following a slower vehicle, preliminary acceleration will be applied when you indicate to overtake.

04. EMERGENCY STEERING ASSIST

When a pedestrian, bicycle, motorbike or vehicle in front is very close to or in your path of travel, Emergency Steering Assist on the new RZ 450e will support your steering movements to enhance the car's stability and prevent accidental lane departure. Compared to normal Emergency Steering Assist, which is driver-triggered, Emergency Steering Assist with active support will operate seamlessly and automatically whenever it is required.

05. PROACTIVE DRIVING ASSIST

Featuring Obstacle Anticipation Assist, Proactive Driving Assist operates the brakes and steering wheel to help the driver avoid pedestrians, cyclists and parked vehicles. Deceleration Assist delivers smooth deceleration when the accelerator pedal is released, when approaching a curve or vehicle in front. The Steering Assist function assists the driver in not deviating from the driving lane. It detects straight driving and curves ahead and adjusts the steering assist force to facilitate proper steering.

06. LANE TRACE ASSIST

The advanced Lane Trace Assist helps keep the new RZ 450e in the centre of the lane using 'lane centring' and 'natural lane trace' functionality, and also provides assistance when driving around bends.

07. FRONT CROSS TRAFFIC ALERT

The system assists in making driving safer at intersections by detecting approaching vehicles from left or right which might be hidden in blind spots and warns the driver via the Head-Up Display and the central multimedia display.

08. EXTENDED SAFETY PACKAGE / LANE CHANGE ASSIST

Alongside Lexus Safety System +, the new RZ 450e features an Extended Safety Package as standard. This includes Lane Change Assistance (LCA), which, once activated by the driver, provides automatic lane change steering on the motorway and Front Cross-Traffic Alert, which uses radar monitoring to warn the driver of traffic approaching from either side.

09. ADAPTIVE HIGH-BEAM SYSTEM

Fitted standard to Luxury grade models, the Adaptive High-beam System prevents the new RZ 450e from dazzling other road users. Independent LED chips in the headlights are enabled/disabled for precise control of the illuminated and non-illuminated areas.

10. ROAD SIGN ASSIST

The upgraded Road Sign Assist (RSA) recognises traffic signs and provides information to the driver via the multi-information display. When linked to Dynamic Radar Cruise Control, the car's speed can be adjusted according to the speed limit recognised by RSA.

LEXUS SAFETY SYSTEM +

01

02

03

04

05

06

07

08

09

10

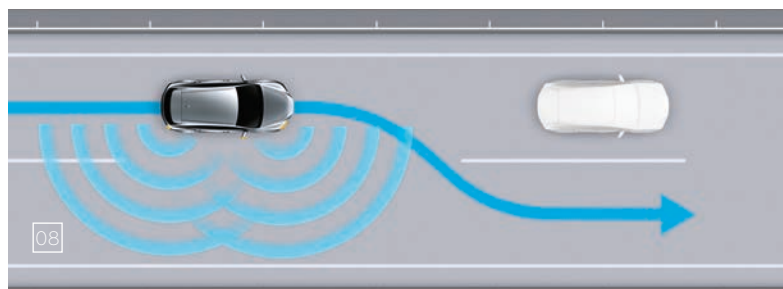
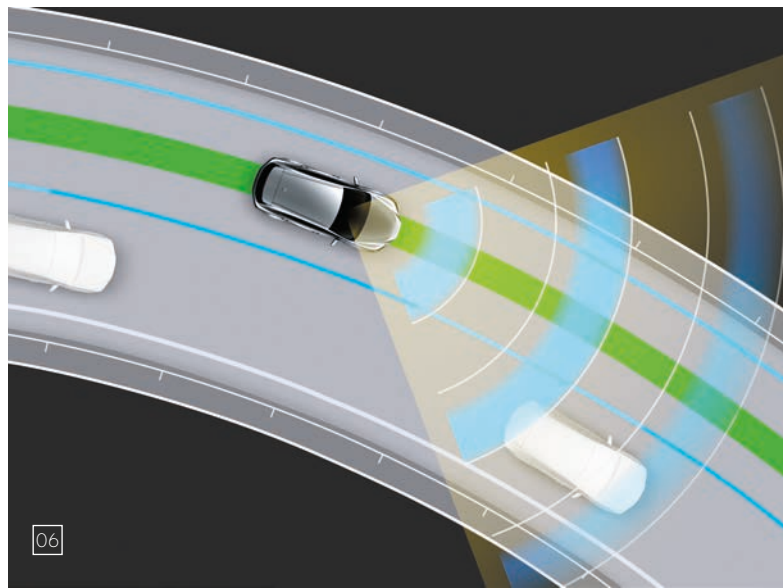
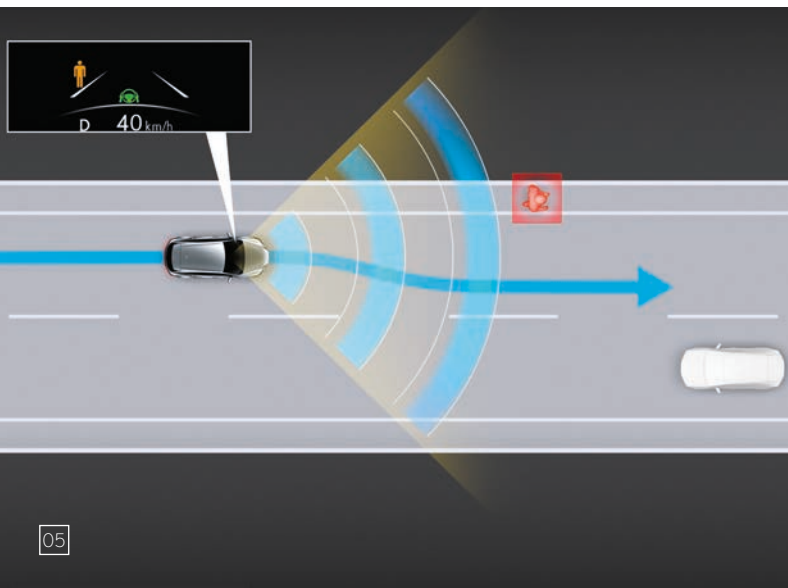
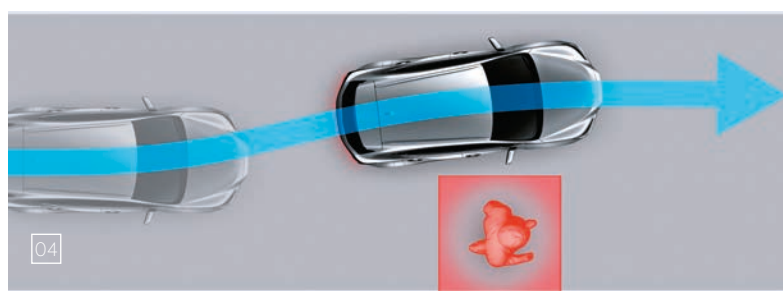
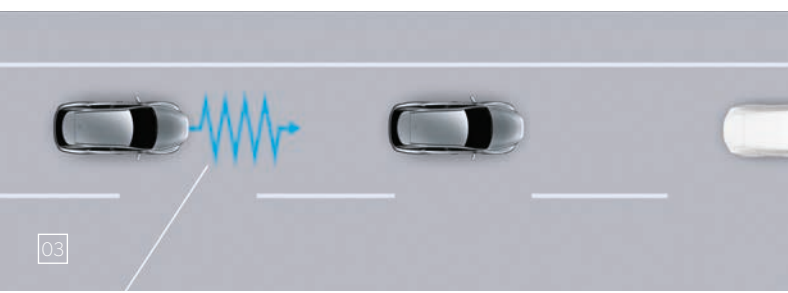

01. AIRBAGS

In addition to an immensely strong passenger safety cell, occupant protection is enhanced by advanced airbags: a dual-stage airbag and knee airbag for the driver; single-stage airbag for the front passenger; centre airbag to reduce contact between the driver and front passenger; side airbags on the front seats and curtain shield airbags that run the full length of both cabin sides.

02. WHIPLASH INJURY LESSENING SEATS

The front seats are designed to minimise whiplash-inducing neck motion in a rear impact. Reinforced seat frames allow the torso to sink into the seatback, while the placement of the headrest supports the head more effectively.

03. DRIVER MONITOR

Driver Monitor uses a camera mounted above the RZ 450e's steering wheel to constantly check the condition of the driver. It is even able to slow or stop the car if the driver fails to react to alerts.

04. DIGITAL PANORAMIC VIEW MONITOR

For easier driving in confined spaces, the Digital Panoramic View Monitor provides a live 360° view around and pre-recorded view under the car. It also creates a virtual 3D image of your RZ 450e, showing the vehicle as if seen from above, with on-screen guides to assist close-quarter manoeuvring and offers the following features:

- Side Clearance View lets you check the clearance when passing another vehicle on a narrow road
- Cornering View helps avoid mounting curbs when cornering
- Front Cross Traffic Alert warns of approaching vehicles and obstacles at the front and sides of the car
- Pre-Collision System & Parking Support Brake warns of a possible collision and will even take preventive action
- A view under the RZ helps you manoeuvre with confidence

05. DIGITAL REAR-VIEW MIRROR

The Digital Rear-View Mirror displays images from a camera at the rear of the car. This 2nd generation system features a lighter bezel, wider view and reduced blind spots. It also enhances your view when the rear seats are occupied, the luggage space is loaded to the roof, or weather and visibility are poor.

06. BLIND SPOT MONITOR

Blind Spot Monitor detects vehicles in adjacent lanes that are not visible in the door mirrors up to 60 metres behind your RZ 450e. If the driver indicates to change lane and a vehicle enters the blind spot, a warning signal appears in the relevant door mirror.

07. REAR CROSS TRAFFIC ALERT

Rear Cross Traffic Alert helps avoid parking collisions during low-speed reversing. The system monitors the area at the rear of the RZ 450e and adjusts speed if it judges there is a possibility of contact with a vehicle. When necessary, the system alerts you with a buzzer, a warning on the 14" display and door mirrors, and will even brake if required.

08. ADVANCED PARK WITH REMOTE PARK

This breakthrough new driver support feature gives you added peace of mind. At the press of a button, Advanced Park with Remote Park scans the environment around you and even allows you to save parking spaces that you use frequently. When leaving a parking space, the system will quickly activate to eliminate annoying waiting time.

09. SAFE EXIT ASSIST

The RZ 450e's e-Latch electronic entry and exit system is linked to the car's Blind Spot Monitor. The exclusive Safe Exit Assist function prevents the driver from opening the door in the event of traffic such as cars or cyclists approaching from the rear.

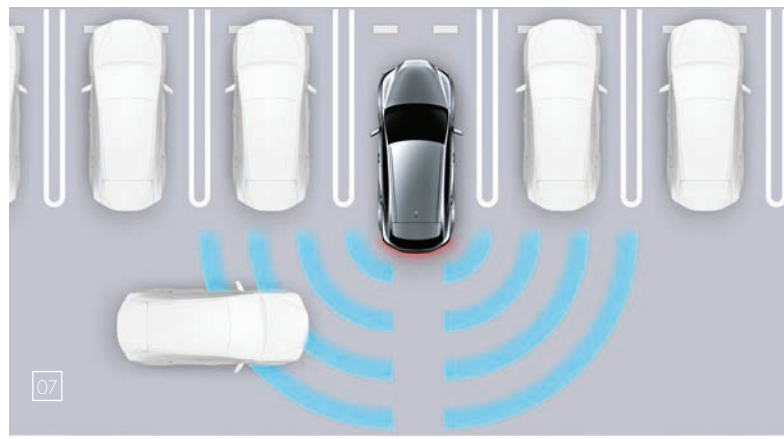
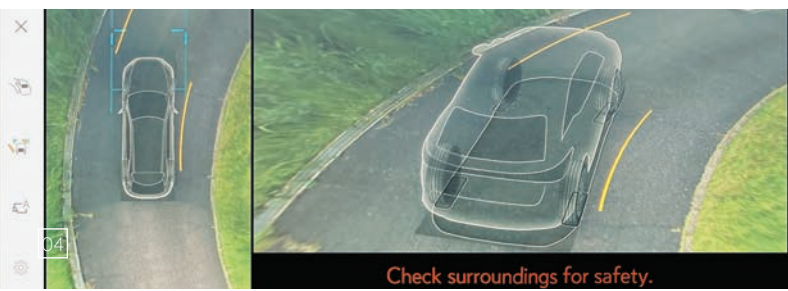

01. ULTRA-STRONG E-TNGA CHASSIS

The quality and characteristics of the RZ 450e's new platform are the foundation for delivering the Lexus Driving Signature. The e-TNGA platform is incredibly strong, with the battery unit integrated into the chassis, beneath the cabin. This also helps lower the car's centre of gravity, which in turn secures better balance, handling and response. High-strength materials and metals are used in the RZ's construction, with advanced construction processes to ensure exceptional strength where elements are joined together, while keeping weight down. This helps ensure precise handling and ride comfort.

Our engineers developed advanced aerodynamics to ensure the new RZ 450e's has world-class performance:

- Front airflow is suppressed, allowing smooth flow
- Front bumper aerodynamics enhance efficiency and range
- Engine bay airflow managed by grille aperture
- Grille shutters control airflow, for efficiency and range
- Flush surface on the body and rear spoiler sides contribute to improved stability
- Underfloor airflow managed by dimpled front cover, the entire underfloor reduces drag
- Rear fins enhance efficiency and driving range, which contributes to driving feel
- Rear window angle, back door shape, rear lamp shape, bumper sides and rear wing contribute to efficiency, range and stability

02. DRIVE MODE SELECT / RANGE MODE

To help you maximise the car's range potential, the RZ's drive modes include a new Range mode. This builds on the energy-saving performance of ECO mode by further adjusting vehicle settings such as speed or climate control limitations. Thanks to this focus, alongside optimised vehicle weight, battery power and performance, the RZ has a target consumption of 16.8 kWh per 100 km¹ for a RZ with 18" wheels, making it one of the most efficient BEVs in its segment.

03. ELECTRIC E-AXLE

The Lexus e-Axle is a compact, modular package which consists of a motor, gearing and an ECU, located between the driven wheels. On the RZ they are used front and rear and operate in conjunction with the DIRECT4 all-wheel drive control system (details below) to adjust the vehicle's posture, traction and power distribution, according to the driving conditions. The e-Axles are quiet, efficient and deliver precise power. The front motor produces 150 kW and the rear 80 kW, giving a total power output of 230 kW. Their compact dimensions also contribute to the car's packaging, helping secure more space in the cabin and load compartment.

04. RZ 450e DIRECT4 DRIVE CONTROL

The RZ 450e features the new DIRECT4 system, working with the two e-Axles. DIRECT4, an exclusive Lexus technology, is an intelligent system that constantly balances the traction to front and rear axles, automatically and seamlessly distributing drive force. The result is stress-free performance and stable handling, with intuitive operation strengthening the sense of connection between driver and machine.

The front/rear torque bias can be adjusted from zero to 100 or 100 to zero in milliseconds – faster than any mechanical system. With better communication between the road and steering wheel, DIRECT4 also improves steering response.

05. NEW FRONT AND REAR SUSPENSION

The RZ 450e's front suspension comprises a newly developed MacPherson strut type system that ensures excellent linear responsiveness to steering inputs. A Lexus-first 'Frequency Reactive Damper' piston delivers improved ride comfort and handling stability. To the rear a newly developed trailing arm type double-wishbone suspension provides the highest level of stability and responsiveness. Our engineers chose a proven suspension to cope with the highly responsive acceleration of a BEV while maximising the characteristic comfort of a Lexus.

¹ The electric range and electric energy consumption values are measured in a controlled environment on a representative production model, in accordance with the requirements of the new WLTP European Regulation EC 2017/1151 and its applicable amendments. For each individual vehicle configuration, the electric range and electric energy consumption values may be calculated based on the ordered optional equipment. The electric range and electric energy consumption values of your vehicle may vary from those measured or calculated values, as driving behaviour as well as other factors (such as road conditions, traffic, vehicle condition, tyre pressure, load, number of passengers, etc) have an influence on a car's electric range and electric energy consumption. 395 km is the range for a RZ with 20" wheels. For more information regarding the new WLTP test method, please visit: www.lexus.eu/wltp#nedc

01

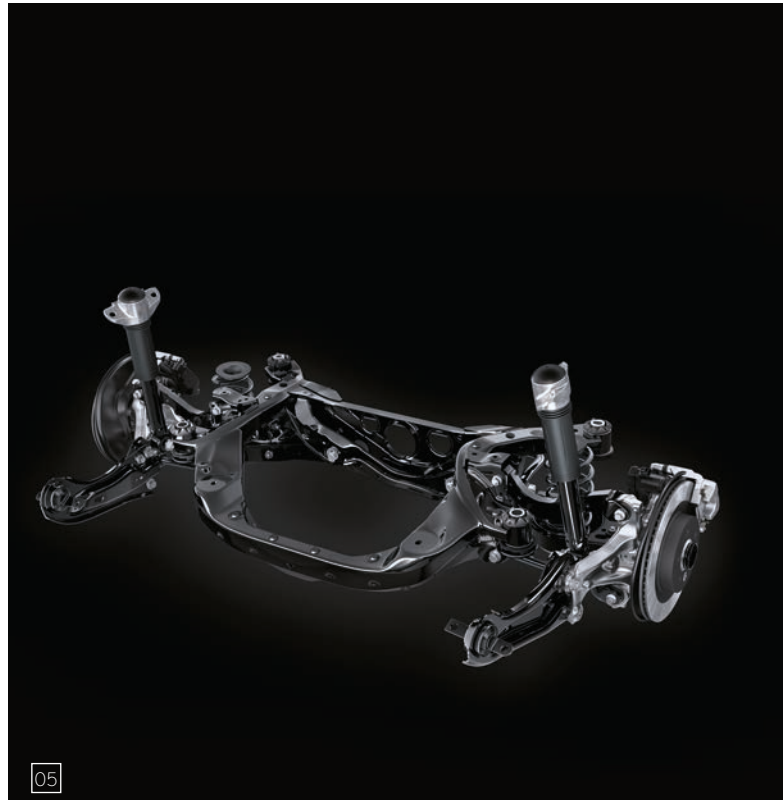
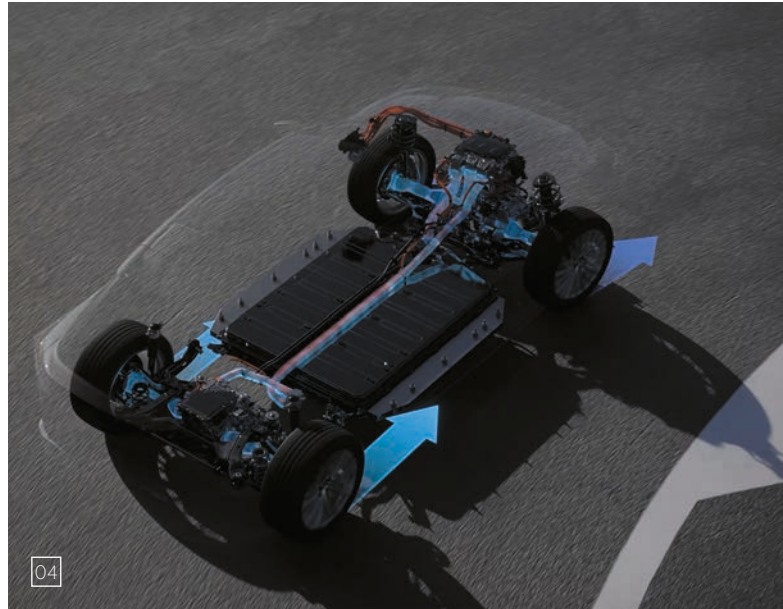
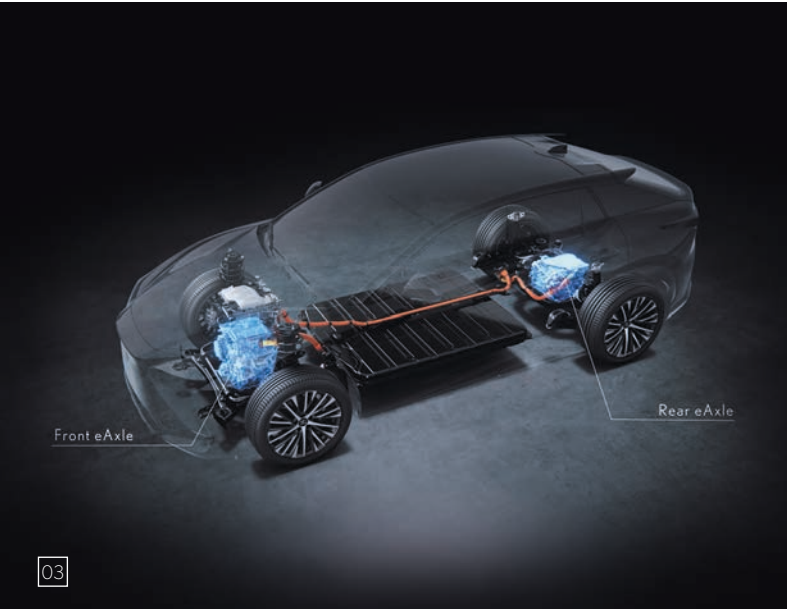

01. ENTRY WALLBOX WITH CHARGING CABLE, 22 KW

One of the smallest of its kind, the 22 kW Entry Wallbox features an integrated charging cable and Type 2 plug for home and semi-public applications. Thanks to its extremely compact dimensions, it is the perfect indoor and outdoor solution for efficient BEV charging.

02. CONNECTED WALLBOX WITH CHARGING SOCKET, 22 KW

Equipped with one Type 2 charging socket, the 22 kW Connected Wallbox is a smart charging solution for home and semi-public applications. Featuring LAN, Wi-Fi and optional LTE, the integrated RFID module ensures fast and secure access. The Connected Wallbox is also prepared for use as a master unit and is suitable for multiple charge point applications.

03. CHARGING CABLE

When charging on the go, use this cable (available in 5 m or 7.5 m lengths) to connect your RZ to a public charging station.

04. CABLE STORAGE BAG

This practical storage bag keeps your charging cable in good condition and prevents it from getting tangled or cluttering your luggage space.

05. LEXUS GLOVE AND TOWEL SET

The Lexus glove and towel set allows for clean handling of the charging cable under different conditions (when the cable is dirty or it's raining outside). While the towel serves to wipe the charging cable clean and dry, the gloves protect your hands and let you handle the charging cable in a safe and hygienic manner. The set comes packed in a practical bag.



01



02



03



04



05



01. TRANSPORT PACK

Vertical Detachable Towing Hitch: The vertical detachable towing hitch has a tough anticorrosion surface and is designed so that you can easily attach and remove the tow ball at your leisure.

Cross Bars - Bike holder: For use with your car's pre-fitted roof rails. The cross bars lock onto the rails and form a secure base for carrying a wide range of specialised attachments such as the bike holder. This lockable, lightweight holder has special grips to secure both the bicycle wheels and the frame.

02. PROTECTION PACK

Textile floor mat: Luxurious yet protective black textile car floor mats. Made of sound-absorbing acuvellour, they are shaped for a perfect fit and the driver's mat has dual safety fixings to prevent it slipping.

Trunk liner: Tailored to fit the boot of your vehicle and provide protection against dirt and spills. The design features a special anti-slip surface pattern to help stop luggage moving.

Protection films: Stone chips, UV rays, road salt, flying bugs - your vehicle's paintwork is constantly under attack, spoiling its appearance and reducing your vehicle's value. Now, you can maintain a showroom fresh appearance with Paint Protection Films. Virtually invisible when applied, they provide the ultimate in long lasting protection and are available for the most vulnerable areas of your vehicle.

Rear seat protector: The Rear Seat back Protector protects the back of the seat from dirt and spills when it's folded down to load longer items. The textured surface helps to prevent items from shifting and sliding.

03. STYLE PACK

18" alloy wheel: The glossy black finish and high performance 5-spoke design create an unmistakable look of urban sophistication.

Premium floor mats (Textile + leather): Stylish textile and leather floor mats for dependable protection of your car's carpets. Safety fixings hold the driver's mat in place.

Illuminated scuff plates: Lexus scuff plates add a stylish design feature while also protecting the door sill paintwork. Their brushed aluminium finish is highlighted by subtle logo illumination.



01



02



03





COLOURS | EXTERIOR

SONIC WHITE | 085



GRAPHITE BLACK | 223

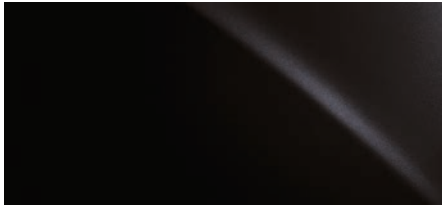

SONIC PLATINUM | 1L2



SONIC COPPER | 4Y5

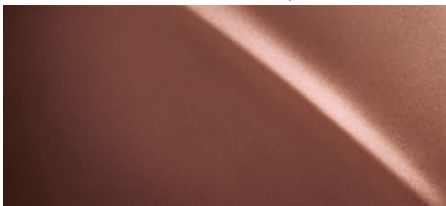

AETHER METALLIC | 8Z2

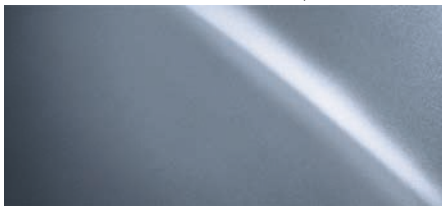

SONIC GREY | 1L1

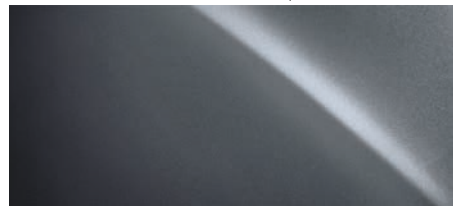

SONIC COPPER / ASTRAL BLACK | 2YF

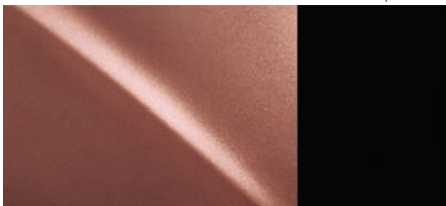

AETHER METALLIC / ASTRAL BLACK | 2YG

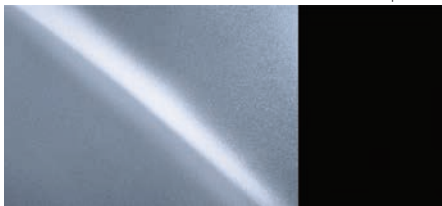

SONIC GREY / ASTRAL BLACK | 2YH

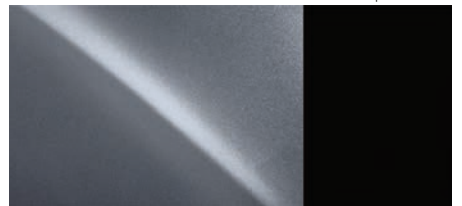

Please note: due to printing variances, actual paintwork colours may vary slightly from those illustrated.



COLOURS | INTERIOR

FABRIC

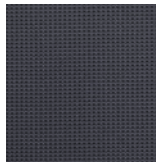

Greyscale

TAHARA

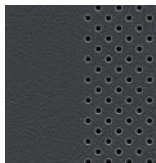

Greyscale

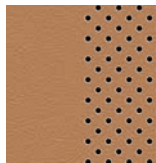

Hazel



Orange

ULTRASUEDE

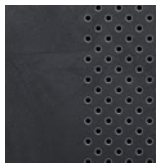

Greyscale



Hazel



Orange

EQUIPMENT | GRADES

EXTERIOR	COMFORT	EXECUTIVE	LUXURY
Heated front L emblem ¹	■	■	■
Headlights, single LED	■	■	■
Headlight cleaners ²	■	■	■
Auto-levelling headlights, static	■	■	–
Auto-levelling headlights, dynamic	–	–	■
Daytime running lights (DRL), LED	■	■	■
Cornering lights, LED	–	–	■
Multi Weather Lights	–	–	■
Dusk sensor	■	■	■
Rear combination lights, LED	■	■	■
Rear fog lights, LED	■	■	■
Acoustic glass, windscreen	■	■	–
Acoustic glass, windscreen, front and rear side glass	–	○	■
Ultra Violet (UV) and heat insulating tinted glass	■	■	■
Rain sensing windscreen wipers	■	■	■
Privacy glass	–	■	■
Driver's door mirror, electro chromatic (auto-dimming)	■	■	■
Door mirrors, electrically adjustable and auto-folding	■	■	■
Door mirrors, aspherical mirror, heated with reverse tilt function	■	■	■
Black outer mirror cover	■	■	■
Puddle lights	■	■	■
Astral Black moulding, wheel arches ³	–	□	■
Astral Black rocker panel ³	–	□	■
Black door belt moulding and side windows frame	■	■	■
Silver roof rails ⁴	○	■	■
11kW (3-phase) AC fast charger with Type 2/Mennekes inlet	■	■	■
150kW DC rapid charger with CCS2 inlet	■	■	■
Intelligent parking assist sensors, front and rear	■	■	■
DIRECT4 badge, rear	■	■	■
Rear bumper, Astral Black ³	–	□	■

WHEELS

18" alloy wheels, machined finish, 235/60 (fr) and 255/55 (rr) R18 tyres	■	■	–
20" alloy wheels, machined finish, 235/50 (fr) and 255/45 (rr) R20 tyres	–	□	■
20" alloy wheels, dark premium metallic, 235/50 (fr) and 255/45 (rr) R20 tyres ⁵	–	□	□

ACTIVE SAFETY AND DRIVING DYNAMICS

Acoustic Vehicle Alerting System (AVAS)	■	■	■
Active brake lights	■	■	■
Automatic High Beam (AHB)	■	■	–
Adaptive High-beam System (AHS)	–	–	■
Advanced Park with Remote Park ⁶	–	□	○
Anti-lock Braking System (ABS)	■	■	■
Automatic Rear Flashing Hazard Lights (ARFHL)	■	■	■
Blind Spot Monitor (BSM) with Rear Cross Traffic Alert and Braking (RCTAB)	■	■	■
Brake Mode Select, 4 modes	■	■	■
Downhill Assist Control (DAC)	■	■	■
Drive Mode Select, Eco / Normal / Custom / Sport / Range	■	■	■
Driver Monitoring System	■	■	■
Dynamic Radar Cruise Control (DRCC), all-speed	■	■	■
Electric Parking Brake (EPB)	■	■	■
Electric Power Steering (EPS)	■	■	■
Electronically Controlled Braking-Regeneration (ECB-R)	■	■	■
Emergency Driving Stop System (EDSS)	■	■	■
Emergency Steering Assist (ESA)	■	■	■

EQUIPMENT | GRADES

ACTIVE SAFETY AND DRIVING DYNAMICS	COMFORT	EXECUTIVE	LUXURY
Front Cross Traffic Alert (FCTA)	■	■	■
Front pedestrian detection	■	■	■
Front cyclist detection	■	■	■
Front motorcyclist detection, daytime only	■	■	■
Front and rear performance dampers ⁷	–	–	■
Hill-start Assist Control (HAC)	■	■	■
Intersection Turn Assist (ITA)	■	■	■
Lane Change Assist (LCA)	■	■	■
Lane Tracing Assist (LTA)	■	■	■
Pre-Collision System (PCS)	■	■	■
Proactive Driving Assist (PDA)	■	■	■
Rear pedestrian detection	■	■	■
Road Sign Assist (RSA)	■	■	■
Speed limiter linked to Road Sign Assist	■	■	■
Safe Exit Assist (SEA)	■	■	■
Traction Control (TRC)	■	■	■
Trailer Sway Control	■	■	■
Tyre Pressure Warning System (TPWS) with Auto location	■	■	■
Vehicle Stability Control (VSC)	■	■	■
PASSIVE SAFETY			
Dual-stage airbags, driver and front passenger	■	■	■
Front centre airbag	■	■	■
Knee airbag, driver and front passenger	■	■	■
Seat cushion airbag, front passenger	■	■	■
Curtain shield airbags	■	■	■
Side airbags, driver and front passenger	■	■	■
Airbag cut-off switch, front passenger	■	■	■
Audible and visual seatbelts reminder, front and rear seats	■	■	■
Seatbelt pre-tensioners, front and rear outer seats	■	■	■
i-Size attachment, outer rear seats	■	■	■
ISOFIX attachment, outer rear seats	■	■	■
SECURITY			
Anti-theft system - siren	■	■	■
Anti-theft system - immobiliser	■	■	■
Anti-theft system - intrusion sensor	■	■	■
Anti-theft system - inclination sensor	■	■	■
Anti-theft system - glass breakage sensor	■	■	■
Double door lock	■	■	■
Auto door locking	■	■	■
Wireless door lock	■	■	■

- Available as standard.
- Available as an option.
- Available as part of a pack.
- Not available.

¹ Available and standard only in select markets.

² Available and standard only in select markets with cold area specification.

³ On Executive grade models available in option packs only with a bi-tone bodycolour selected.

⁴ Silver roof rails are not equipped when an optionally available panoramic glass sunroof is selected.

⁵ Available in an option pack on Executive grade models or in the Bi-tone design pack on Executive and Luxury grade models with a bi-tone bodycolour selected. Front and rear performance dampers can't be equipped together with any of these option packs.

⁶ Remote Park function is not available in all markets.

⁷ Performance dampers are not equipped when the optional 20" alloy wheels in dark premium metallic, and/or towing capability are selected

EQUIPMENT | GRADES

AUDIO, COMMUNICATION AND INFORMATION	COMFORT	EXECUTIVE	LUXURY
7" colour multi-information display	■	■	■
Digital speedometer	■	■	–
Digital speedometer, high-definition display	–	□	■
Head-Up Display (HUD)	–	□	■
Lexus Link Pro - 14" touchscreen display	■	■	■
Lexus Link Pro Embedded Hybrid Navigation ¹	■	■	■
Lexus Link Standard Connectivity	■	■	■
Lexus Link Premium Connectivity (4 years) ¹	■	■	■
Bluetooth® mobile phone and audio connectivity	■	■	■
Smartphone integration (Wireless Android Auto®, Wireless Apple CarPlay®)	■	■	■
Wireless smartphone charger	○	■	■
10-speaker premium audio system	■	■	■
13-speaker Mark Levinson® Premium Surround Sound System	–	–	○
Antenna, shark fin design	■	■	■
Digital Audio Broadcasting (DAB) radio	■	■	■
USB port (Type-C), front centre console	■	■	■
2 USB charging ports (Type-C), front centre console	■	■	■
2 USB charging ports (Type-C), rear centre console	■	■	■
12V socket, front	■	■	■
12V socket, rear	■	■	–
12V socket, luggage compartment	■	■	■
220V socket, rear	–	–	■
Active Sound Control (ASC)	■	■	■
Emergency Response System (eCall)	■	■	■
Parking assist monitor with on-screen guides	■	■	–
Digital Panoramic View Monitor (PVM)	–	□	■
Steering wheel mounted controls, audio / display / phone / voice / DRCC / LTA	■	■	–
Steering wheel mounted customizable touch controls	–	□	■
SEATS			
Fabric upholstery	■	–	–
Tahara trim	–	■	–
Ultrasuede® upholstery	–	–	■
Driving position memory (seat, steering wheel, outer mirrors) - 3 user profiles	–	□	■
Radiant heater, front seats	–	□	■
Heated front seats	■	■	■
Ventilated front seats	–	□	■
6-way manually adjustable front seats	■	–	–
8-way electrically adjustable front seats	–	■	■
2-way lumbar support, driver seat	–	■	■
2-way manually adjustable front headrests	■	■	■
Heated outer rear seats	–	–	■
Manually folding rear seat backrest, 60/40 split	■	■	■
2-way manually adjustable rear headrests	■	■	■

EQUIPMENT | GRADES

INTERIOR COMFORT AND CONVENIENCE	COMFORT	EXECUTIVE	LUXURY
3-spoke, Tahara trimmed steering wheel	■	■	■
Paddle-selector controls	■	■	■
Heated steering wheel	○	○	■
Steering column, manually multi-adjustable	■	■	–
Steering column, electrically multi-adjustable	–	□	■
Easy entry and exit function, driver seat retracts/returns	–	□	■
Easy entry and exit function, steering wheel retracts/returns	–	□	■
Single-colour ambient lighting	■	■	■
Multi-colour ambient lighting (64 colours)	–	–	○
'In-ei' lighting	–	■	■
Rear-view mirror, electro chromatic (auto-dimming)	■	■	■
Digital rear-view mirror ²	–	○	○
Sunglasses holder, overhead front console	■	■	■
e-Latch door lock system	■	■	■
Door panel finish, Tahara trim	■	■	–
Door panel finish, Ultrasuede®	–	–	■
Panoramic glass sunroof ³	–	○	–
Panoramic glass sunroof, dimmable ^{2,3}	–	–	○
Automatic air recirculation control	■	■	■
Clean air filter with pollen removal and deodoriser	■	■	■
Electronic climate control with nanoe™ X technology	○	○	■
Electronic climate control, 2-zone	■	■	■
Humidity sensor for climate control	■	■	■
S-Flow technology for climate control	■	■	■
Remote climate control	■	■	■
Lexus Climate Concierge	–	□	■
Windscreen de-icer ⁴	■	■	■
Door courtesy lights, LED	–	■	■
Front centre console, Wood Grain finish	–	■	■
Smart entry and start system	■	■	■
Smart key, Ultra-Wideband (UWB)	■	■	■
Stainless steel scuff plates with LEXUS inscription, front doors	■	■	■
Storage bag, front centre armrest	■	■	■
Luggage cover board, manually folding	■	■	■
Tyre repair kit	■	■	■
Stainless steel scuff plate, tailgate	■	■	■
Tailgate, electric lift and close with height memory function	–	○	■
Tailgate, kick-open function ⁵	–	–	■

■ Available as standard.

○ Available as an option.

□ Available as part of a pack.

– Not available.

¹ Premium Connectivity pack is included with Lexus Link Pro for the first 4 years of ownership, and renewable thereafter on a subscription basis.

² Optionally available digital rear view mirror and dimmable panoramic glass roof can't be equipped together.

³ Silver roof rails are not equipped when an optionally available panoramic glass sunroof is selected.

⁴ Available and standard only in select markets with cold area specification.

⁵ Kick-open function is not available with towing capability selected.

EQUIPMENT | PACKS

PACKS	COMFORT	EXECUTIVE	LUXURY
Lexus Safety System+¹			
Automatic High Beam (AHB)	■	■	–
Adaptive High-beam System (AHS)	–	–	■
Auto-levelling headlights, dynamic	–	–	■
Driver Monitoring System	■	■	■
Dynamic Radar Cruise Control (DRCC), all-speed	■	■	■
Emergency Driving Stop System (EDSS)	■	■	■
Emergency Steering Assist (ESA)	■	■	■
Front Cross Traffic Alert (FCTA)	■	■	■
Front cyclist detection	■	■	■
Front motorcyclist detection, daytime only	■	■	■
Front pedestrian detection	■	■	■
Intersection Turn Assist (ITA)	■	■	■
Lane Change Assist (LCA)	■	■	■
Lane Tracing Assist (LTA)	■	■	■
Pre-Collision System (PCS)	■	■	■
Proactive Driving Assist (PDA)	■	■	■
Road Sign Assist (RSA)	■	■	■
Speed limiter linked to Road Sign Assist	■	■	■
Black gloss pack²			
Astral Black moulding, wheel arches	–	□	■
Astral Black rocker panel	–	□	■
Rear bumper, Astral Black	–	□	■
Black 20" wheels pack			
20" alloy wheels, machined finish, 235/50 (fr) and 255/45 (rr) R20 tyres	–	□	■
Steering column, electrically multi-adjustable	–	□	■
Panoramic view pack			
Digital Panoramic View Monitor (PVM)	–	□	■
Steering column, electrically multi-adjustable	–	□	■
Seat memory and ventilation pack			
Driving position memory (seat, steering wheel, outer mirrors) - 3 user profiles	–	□	■
Easy entry and exit function, driver seat retracts/returns	–	□	■
Easy entry and exit function, steering wheel retracts/returns	–	□	■
Ventilated front seats	–	□	■
Lexus Climate Concierge	–	□	■
Radiant heater pack			
Radiant heater, front seats	–	□	■
Steering column, electrically multi-adjustable	–	□	■

EQUIPMENT | PACKS

PACKS	COMFORT	EXECUTIVE	LUXURY
Cockpit upgrade pack			
Digital speedometer, high-definition display	–	□	■
Head-Up Display (HUD)	–	□	■
Steering wheel mounted customizable touch controls	–	□	■
Steering column, electrically multi-adjustable	–	□	■
Tech pack			
contents of the Radiant heater pack	–	□	■
contents of the Cockpit upgrade pack	–	□	■
Digital Panoramic View Monitor (PVM)	–	□	■
Advanced Park			
contents of the Panoramic view pack	–	□	■
Advanced Park with Remote Park ³	–	□	○
Bi-tone design pack⁴			
contents of the Black gloss pack	–	□	■
20" alloy wheels, dark premium metallic, 235/50 (fr) and 255/45 (rr) R20 tyres	–	□	□
Steering column, electrically multi-adjustable	–	□	■

- Available as standard.
- Available as an option.
- Available as part of a pack.
- Not available.

¹ Do not use the Lexus Safety System + instead of normal driving under any circumstances and please read the instructions before operating the system. The driver is always responsible for driving safely.

² Black gloss pack is only available with a bi-tone bodycolour selected.

³ Remote Park function is not available in all markets.

⁴ Bi-tone design pack is optionally available with a bi-tone bodycolour selected. Front and rear performance dampers can't be equipped when selected.

TECHNICAL DATA

EV SYSTEM	RZ 450e
Motors Type	AC synchronous, permanent magnet
Maximum power (DIN hp) front / rear	204 / 109
Maximum power (kW) front / rear	150 / 80
Maximum torque (Nm)	266/ 169
Reduction drive	Single speed
Drive	DIRECT4
TOTAL SYSTEM OUTPUT¹	
Total power (DIN hp)	313
Total power (kW)	230
CHARGING	
Battery type	Lithium ion
Battery capacity (kWh)	71.4
Maximum charging power AC ² (kW)	11
10 - 100% charging time AC ³ (h : min)	6:30
Maximum charging power DC ⁴ (kW)	150
Charging time DC ³ (h : min)	0:30
PERFORMANCE	
Maximum speed (km/h)	160
Acceleration 0-100 km/h (s)	5.3
RANGE⁵ (km)	
Combined	395 - 440
ELECTRIC CONSUMPTION⁵ (kWh/ 100km)	
Combined	16.8 - 18.7
CO₂ EMISSIONS⁵ (g/km)	
Combined	0
WEIGHTS (kg)	
Gross vehicle	2640
Kerb weight ⁶ (min. - max.)	2055 - 2070 / 2075 - 2095 / 2085 - 2105 / 2100 - 2115
CAPACITIES	
Luggage volume - rear seats upright, loaded to the roof ⁷ (l)	586
Luggage volume - rear seats folded, loaded to the roof ⁷ (l)	1515
Towing capacity max. unbraked ⁸ (kg)	750
Towing capacity max. braked ⁸ (kg)	750

¹ Combined electric motors.

² For charging at 11 kW, an AC charger with a three-phase supply of 16 A or greater is required. When charging at an AC electrical socket with an AC charging cable, the maximum charging power will be lower, depending on the specifications of the power supply available. The charging current setting enables the user to select a maximum charge current available to prevent the breaker inside the house being tripped during charging.

³ Approximate charging time based on internal measurements and predicted values, intended solely for comparison between different models. The time required until completion of charging may vary due to factors such as the age, type, condition and temperature of the charging unit, the age, type, condition, charge level and temperature of the drive battery, the outside air temperature, and the specifications of the power supply.

Charging time DC indicates the time taken from when the low drive battery level warning light is lit until 80% charge is reached.

⁴ For charging at 150kW a DC charger stand conforming to the CCS2 standard with a maximum output of 150 kW (400 A) or greater is required.

⁵ The electric range and electric energy consumption values are measured in a controlled environment on a representative production model, in accordance with the requirements of the new WLTP European Regulation EC 2017/1151 and its applicable amendments. For each individual vehicle configuration, the electric range and electric energy consumption values may be calculated based on the ordered optional equipment. The electric range and electric energy consumption values of your vehicle may vary from those measured or calculated values, as driving behaviour as well as other factors (such as road conditions, traffic, vehicle condition, tyre pressure, load, number of passengers, etc) have an influence on a car's electric range and electric energy consumption. For more information regarding the new WLTP test method, please visit: www.lexus.eu/wltp#nedc

⁶ The kerb weight differs by grade and alloy wheel sizes. The first figures shown are for Comfort grade, the second for Executive grade with 18" alloy wheels, the third for Executive grade with 20" alloy wheels and the fourth for Luxury grade.

⁷ Luggage volume figures are as per the VDA method. All figures quoted include the maximum under floor storage area in the luggage compartment. The available underfloor storage area may differ in certain countries.

⁸ Towing capacity does not include tow-bar or other towing equipment as standard.

Please note: Further Technical Data, including any updates, can be found at www.lexus.eu

TECHNICAL DATA

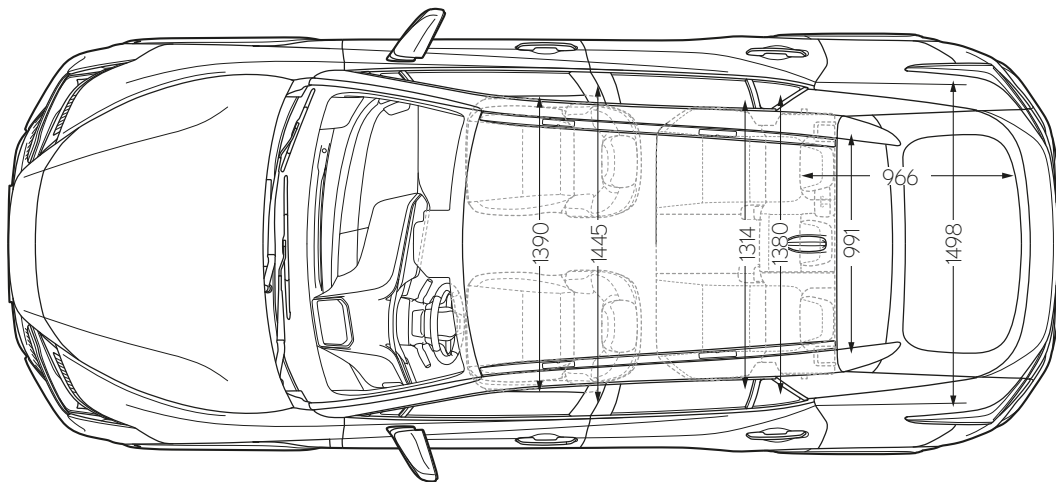
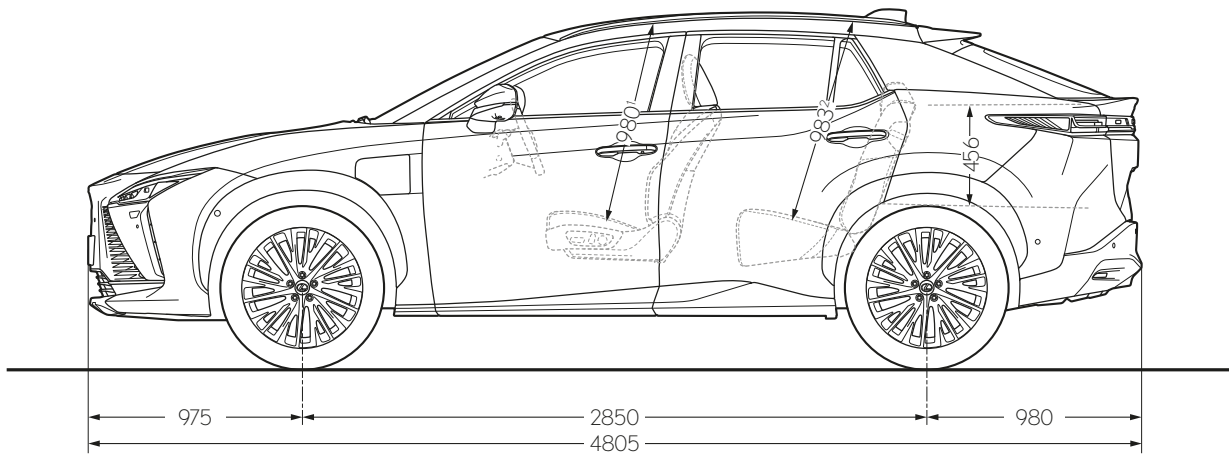
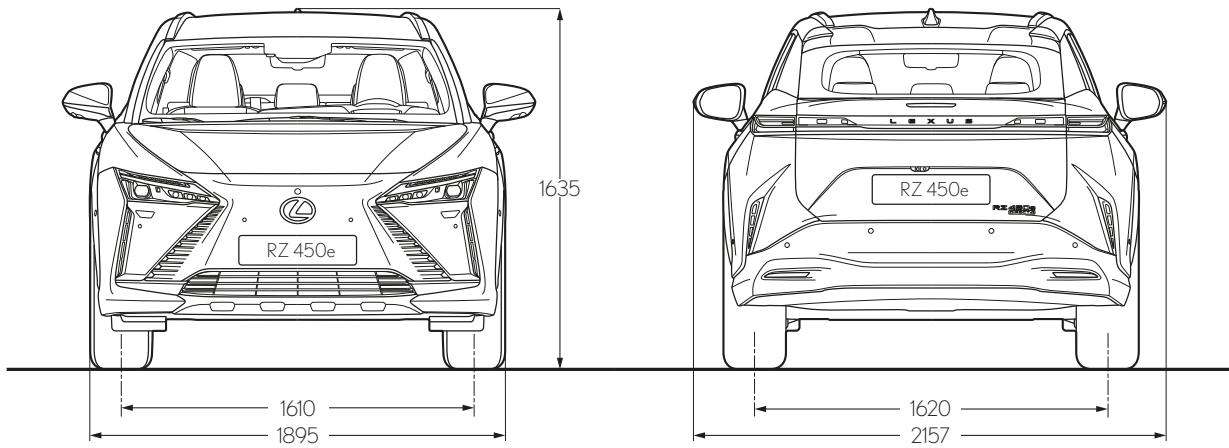

¹ The figure quoted is for models with standard roof. When equipped with an optional panoramic glass sunroof the value is 1013.
² The figure quoted is for models with standard roof. When equipped with an optional panoramic glass sunroof the value is 1008.

Please note: the dimensions illustrated above are measured in millimetres.

BE OUR GUEST

HOW WE TREAT OUR CUSTOMERS IS GUIDED BY AN ANCIENT JAPANESE PHILOSOPHY OF HOSPITALITY.

Translated from the Japanese as 'hospitality and polite service', Omotenashi is about much more than excellence of service; it is an ancient concept centred around anticipating the needs of another, even before they arise. Omotenashi influences how we design and engineer our cars at Lexus, and equally how we treat you, the Lexus owner. Not just at the point of sale but over the life of your car. We want you to feel valued in every interaction you have with us. To feel more than a customer.

Whether as a private or fleet driver, you'll experience Omotenashi each time you visit our showrooms. In the warm reception on hand from friendly staff intent on welcoming you as if you were a guest in their home. In the inviting atmosphere and impressive facilities of the lounge, where you can avail of refreshments, catch up on news, enjoy high-speed Internet or carry on with your work. And in the knowledge that our Lexus technicians are working with precision and efficiency to get you back on the road with minimum interruption to your day.

PEACE OF MIND WITH LEXUS RELAX*

Lexus Relax provides you with complete peace of mind even after your manufacturer's warranty expires. Drive away carefree with an extra 12 months warranty every year you service your Lexus with us.

LEXUS EASY MOBILITY SOLUTION*

From financing to insurance, maintenance and even tyres, the Lexus Easy flexible mobility solution is the easy way to drive and look after a Lexus.

It's not only cars that make Lexus unique. It's the philosophy which permeates everything we do and which extends to an ownership experience that makes you feel special. Just as a guest should.

* Lexus Relax and Lexus Easy are not available for all markets.
Please enquire at your local Lexus Authorised Retailer.



**ÊTES-VOUS OUVERT À
CE QUI VOUS SURPRENDRA ?**
Mettre à jour votre connaissance de la vie.

VOUS CONCERNEZ-ILS ?

PROFIL	PROFIL	PROFIL	PROFIL
1. PROFIL 1	2. PROFIL 2	3. PROFIL 3	4. PROFIL 4
5. PROFIL 5	6. PROFIL 6	7. PROFIL 7	8. PROFIL 8
9. PROFIL 9	10. PROFIL 10	11. PROFIL 11	12. PROFIL 12
13. PROFIL 13	14. PROFIL 14	15. PROFIL 15	16. PROFIL 16
17. PROFIL 17	18. PROFIL 18	19. PROFIL 19	20. PROFIL 20

LENSIS



DISCOVER MORE ONLINE

Find out more about the new RZ 450e and even reserve your car online. Take time to explore which equipment grade best suits your lifestyle, learn about our world-class service and finance offerings and sign up to our regular newsletter. If you're interested in how the new RZ feels to drive, you can also book a test drive online with your local Lexus Retailer.

<https://www.lexus.eu/new-cars/rz>

©2023 Lexus Europe* reserves the right to alter any details of specifications and equipment without notice. Details of specifications and equipment are also subject to change to suit local conditions and requirements. Please enquire at your local Lexus Authorised Retailer of any such changes that might be required for your area.

Note: vehicles pictured and specifications detailed in this brochure may vary from models and equipment available in your area. Vehicle body colour might differ slightly from the printed photos in this brochure.

For further information please visit our website: www.lexus.eu

Taking care of the environment is a priority for Lexus. We take many measures to ensure that during the lifecycles of our vehicles - from design, production, distribution, sales and service to end-of-life - their environmental impact is minimised. Your retailer will be happy to provide more information on end-of-life vehicle requirements.

* Lexus Europe is a division of Toyota Motor Europe NV/SA.

Printed in Europe, March 2023

 **LEXUS**
EXPERIENCE AMAZING